

Left to Right Model

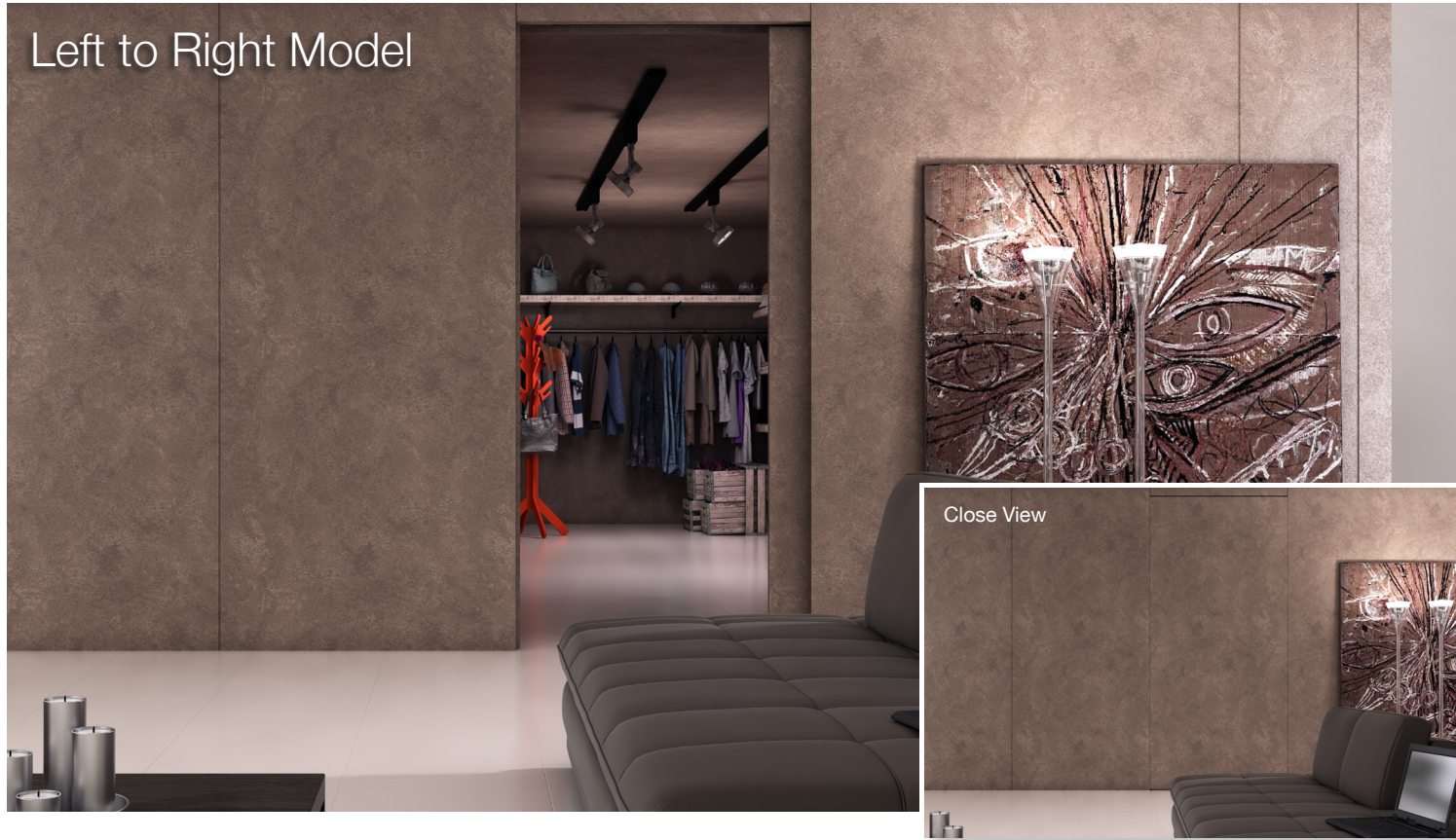

Close View



FLUSH SLIDING DOOR SYSTEM

Right to Left Model



Open View



Top Hung Sliding System



No Groove on Floor Surface Needed



View from the Inside

LIT-MFU1200-2021



Sugatsune America
18101 Savarona Way
Carson, CA 90746
www.sugatsune.com



Share or watch
this video
featuring our
MFU1200 Flush
Sliding Door
System in action.



MFU1200 SYSTEM

FLUSH SLIDING DOOR SYSTEM

MFU1200

	MFU1200-40	MFU1200-70
Door Width	31-1/2"~47-1/4" (800~1200 mm)	
Door Height	Max. 106-5/16" (2700 mm)	
Door Thickness	1-3/16"~1-9/16" (30~40 mm)	
Door Weight	44~88 lbs (20~40 kg)	88~154 lbs (40~70 kg)
Adjustability	Depth:	±3.5 mm (1/8")
	Horizontal:	±4 mm (3/16")
	Vertical:	±4 mm (3/16")

- Designed to CLOSE FLUSH against surrounding walls, providing clean appearance.
- UNIQUE MOVEMENT: Recesses in, and then slides sideways.
- CLEAN APPEARANCE: No floor tracks required on MFU-System.
- Excellent performance, reliable and fully adjustable.
- Features two way damper to avoid slamming open or closed.
- DURABILITY: High durability, passed 100,000 open/close cycle test (private).

RIGHT TO LEFT OPENING

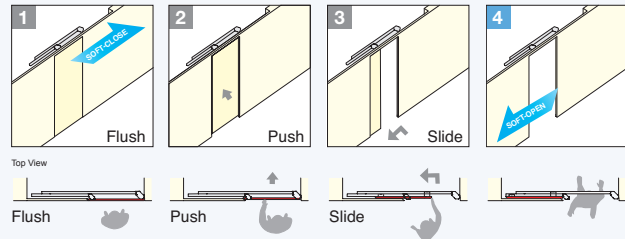

Item No.	Opening	Door Weight
MFU1200-40-R (Light duty Right)	Right to Left	44 - 88 lbs (20-40 kg)
MFU1200-70-R (Heavy duty Right)	Right to Left	88-154 lbs (40-70 kg)

LEFT TO RIGHT OPENING

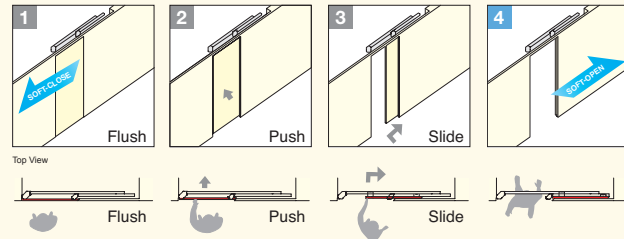

Item No.	Opening	Door Weight
MFU1200-40-L (Light duty Left)	Left to Right	44 - 88 lbs (20-40 kg)
MFU1200-70-L (Heavy duty Left)	Left to Right	88-154 lbs (40-70 kg)

Installation

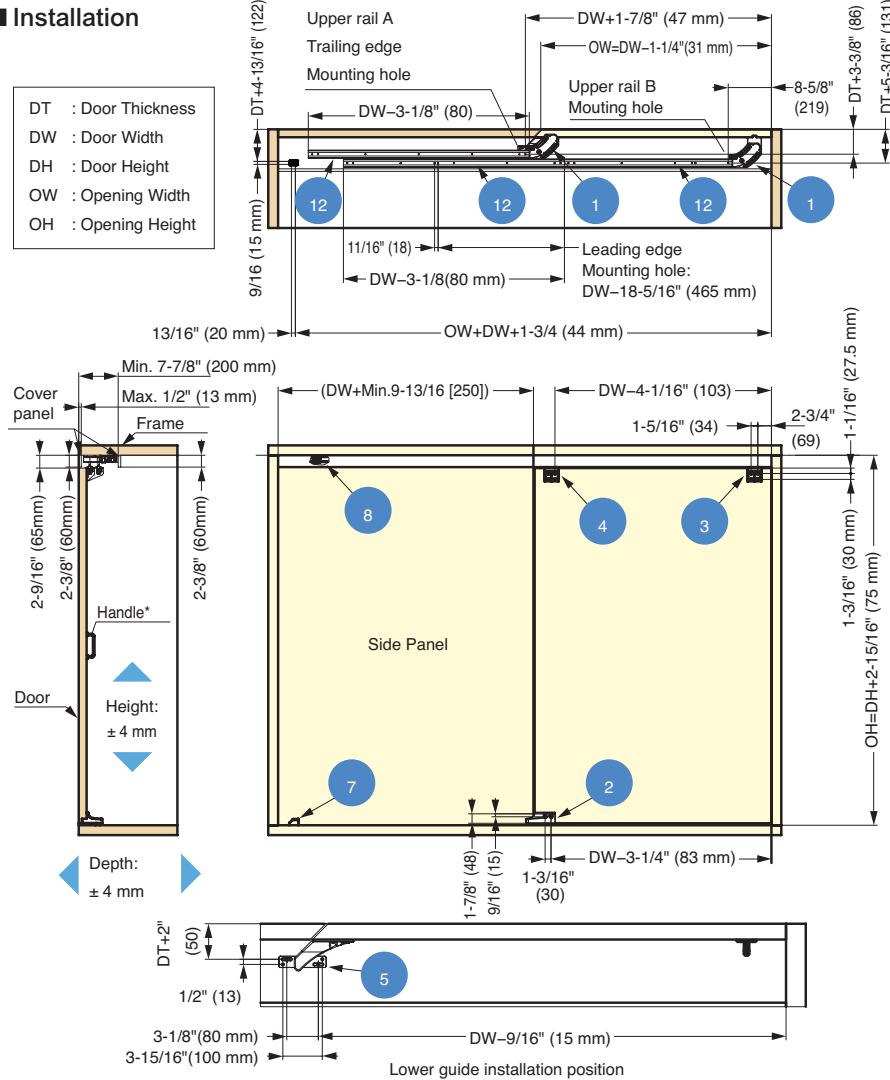

Chamfering

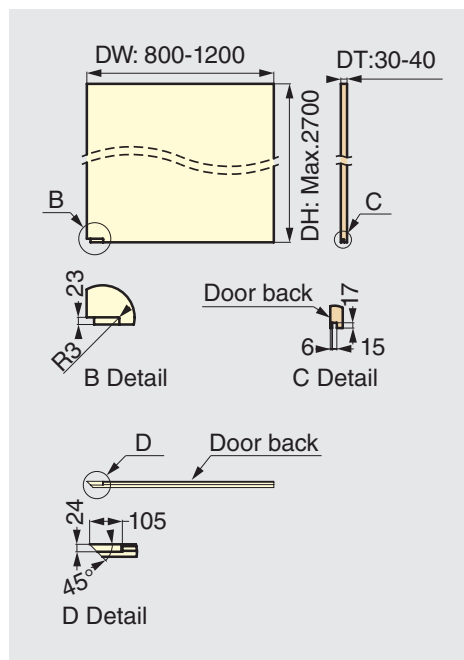
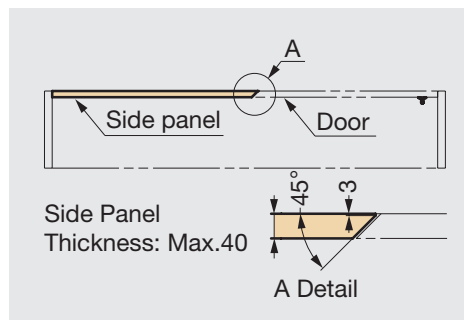

Part Details

Self-Close Rollers

included

Item No. determined by door weight

No.	Type	Item No.	Part Name	Drawing	Description
11	Door Weight 44-88 lbs (20-40 kg)	MFU1200-40DSC-BL	Soft closer (leading edge)		•Material: steel/POM •Finish: electro-deposition / black
		MFU1200-70DSC-BL	Door roller (trailing edge)		•Material: steel •Finish: electro-deposition / black

Tracks

included

No.	Item No.	Part Name	Drawing	Description
12	MFU1200-RS-BL	Upper track A*		•Material: aluminium alloy •Finish: black anodising + coating / clear
		Upper track B		
		850mm		•Material: aluminium alloy •Finish: silver anodising + coating / clear
		Bottom guide channel		

* Cut upper track A and bottom track according to the door size.

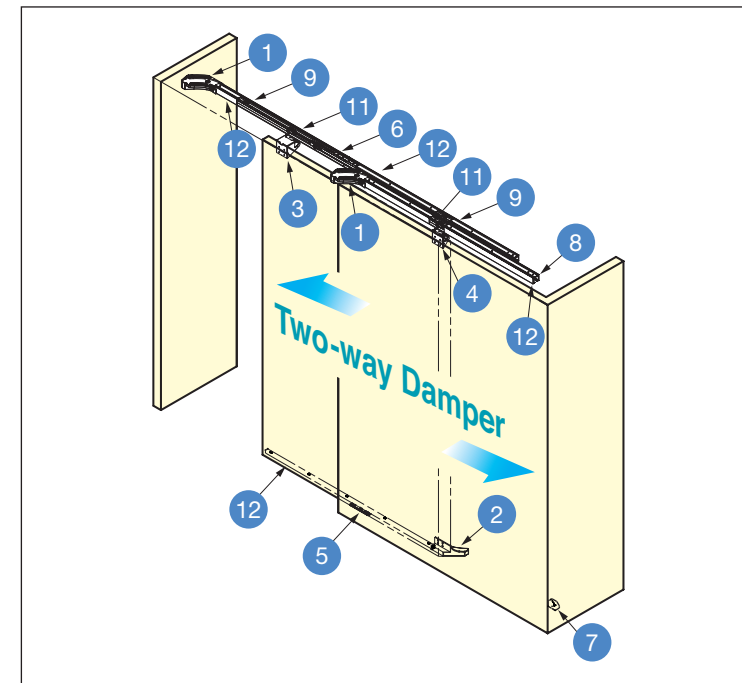

Item Name	Description
MFU1200-L-BL	Left to Right Opening
MFU1200-R-BL	Right to Left Opening

Detail

No.	Qty	Part Name	Drawing (L type) in mm	Description
1	2	Guiding track (top)		•Material: aluminium alloy •Finish: enamel / black
2	1	Guiding track (bottom)		•Material: aluminium alloy •Finish: enamel / black
3	1	Bracket (leading edge)		•Material: steel •Finish: enamel / black
4	1	Bracket (trailing edge)		•Material: steel •Finish: enamel / black
5	1	Bottom guide		•Material: steel / POM •Finish/Color: electro-deposition / black
6	1	Connecting plate		•Material: steel •Finish: electro-deposition / black
7	1	Door stopper (floor)		•Material: zinc alloy / elastomer •Finish/Color: chromate treatment (trivalent)/grey
8	1	Bumper block		•Material: steel/elastomer •Finish/Color: chromate/grey
9	2	Trigger		•Material: steel •Finish: chromate treatment (trivalent)
10	1	Jig		Can be ordered separately Item Name: FD80-TRJ •Material: POM •Color: green