

# CONCEALED HINGE (9mm OVERLAY)

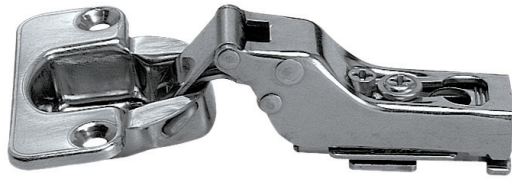

# 304B-46/9, C46/9



■ Door edge to bore edge distance (C) and Overlay distance (B) Table 1.

Door edge to bore edge distance (C)	3	4	5
Overlay distance (B)	7	8	9

■ Hinge side opening clearance chart Table 2.

Door thickness (D)	Door edge to bore edge distance (C)		
	3	4	5
15	0.5	0.5	0.5
16	0.7	0.7	0.7
17	0.8	0.8	0.8
18	1.0	1.0	1.0
19	1.2	1.2	1.2
20	1.4	1.4	1.4

Hinge side O.C. (A)

\*Mounting Plate sold separately. See P.297

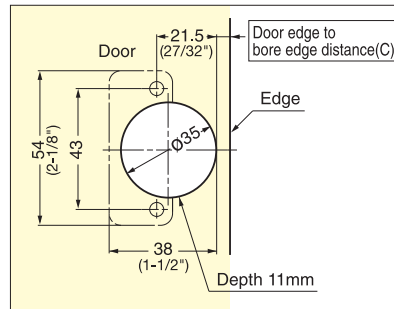
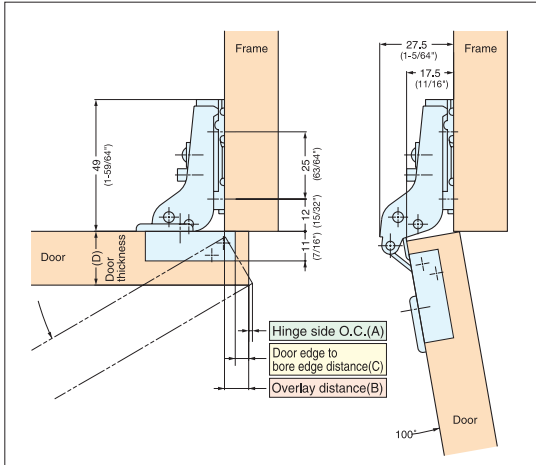

Bore Dimensions

Item No.	Type	Weight (g)	Carton (pcs)	Material	Finish
304B-46/9	Free Swinging	60	200	304 Stainless Steel	Polished
304B-C46/9	Self-Closing				

# MOUNTING PLATE FOR 304B SERIES HINGES



• Mounting plate for 304B hinges.

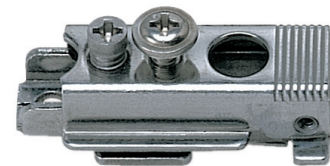

304B-P3A

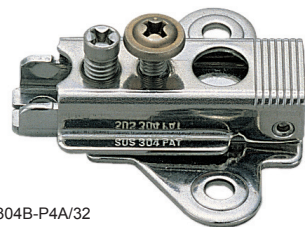
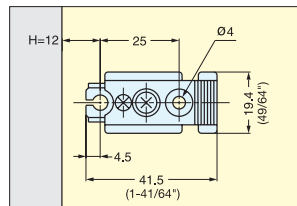

304B-P4A/32

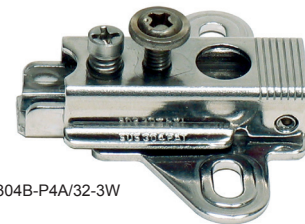
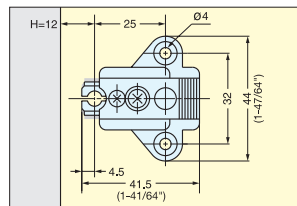

304B-P4A/32-3W

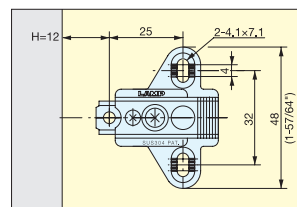

Installation

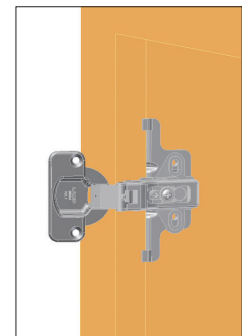

Face Frame Bracket for 304B-P4A/32 and 304B-P4A/32-3W. See P.344 (Sold separately)

Item No.	Weight (g)	Carton (pcs)	Material	Finish
304B- P3A	40	400	304 Stainless Steel	Polished
304B- P4A/32				
304B- P4A/32-3W				